

RVM5916

UNDERMOUNT KITCHEN SINK

RUVATI[®]
SPECIFICATION SHEET

MATERIAL

True 16 Gauge Thickness
Premium T304 Grade Stainless Steel
18/10 Chromium/Nickel Content
Commercial Brushed Finish

FEATURES

- Heavy duty sound guard padding and undercoating
- Curved bowl and rounded bottom for perfect drainage
- Large deep bowl

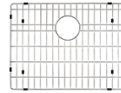

IN THE BOX



Basket Strainer
[RVA1025]

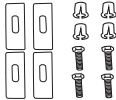

Mounting Clips
[RVA11031]



Cut-out
Template

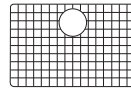

Rinse Grid
[RVA65916]

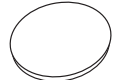

Drain Cover
[RVA1035]

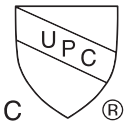

cUPC certified by IAPMO to meet US and Canada plumbing standards.
Codes compliance: ASME A112.19.3/CSA B45.4

NOMINAL DIMENSIONS

Exterior: 18" (wide) x 16" (front-to-back)
Interior Bowl: 16" (left) x 14" (right)
Bowl Depth: 9"
Minimum Cabinet Size: 21" wide
Drain Hole Size: 3½"

Installation Type:
Undermount
Inside Corners:
Rounded
Drain Location:
Rear Center

RUVATI USA
www.ruvati.com

Phone: 1.855.478.8284
Email: support@ruvati.com

OPTIONAL ACCESSORIES (SOLD SEPARATELY)



Deep Basket
Disposal Flange
[RVA1049ST]

DIMENSIONS

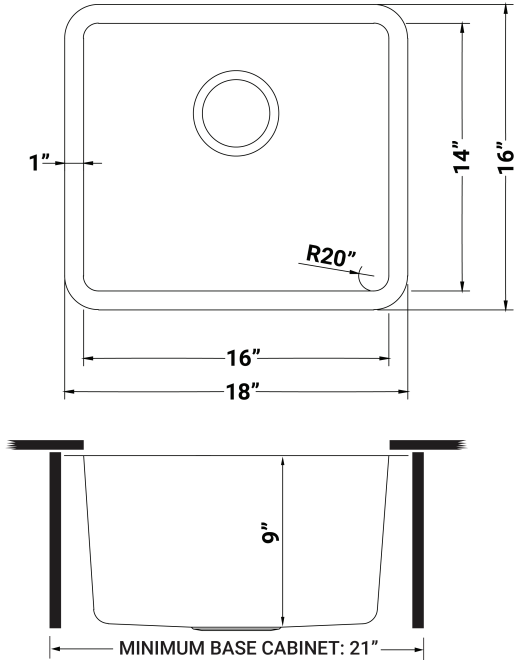

Register your product at www.ruvati.com/register.